

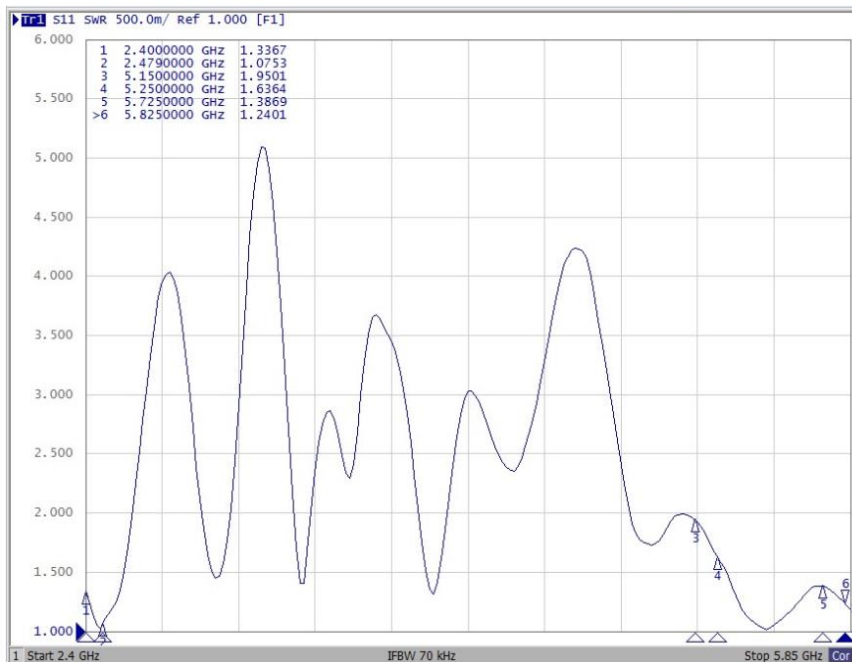

Antenna Specifications

Frequency Range	2400 - 2483 MHz 5150 - 5875 MHz
Gain	4 dBi @ 2400 – 2483 MHz 6 dBi @ 5150 – 5875 MHz
VSWR	2.0 : 1 Max.
Radiation	Omni Direction
Impedance	50 Ω
Connector	N male
Dimensions	Φ22x180 mm
Weight	70 g
Temperature	-40 °C to 85 °C
Humidity	95% @ 25 °C

V.S.W.R



➤ Radiation Pattern

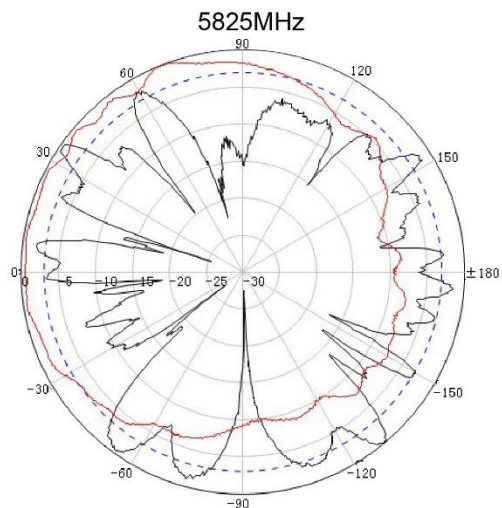
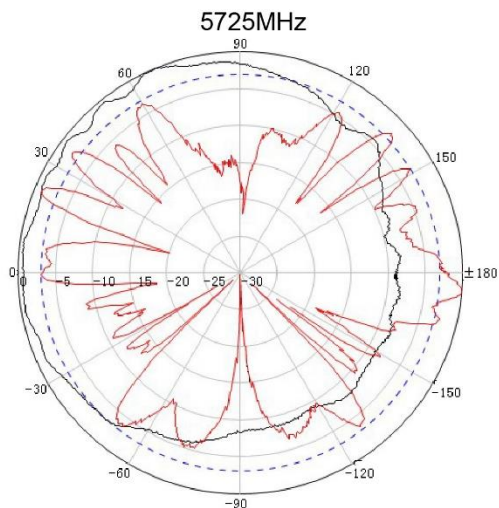
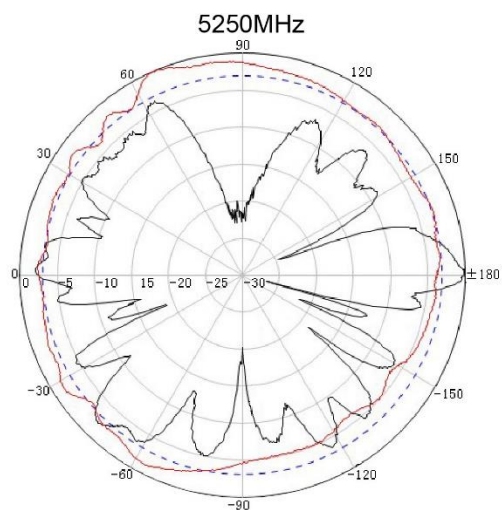
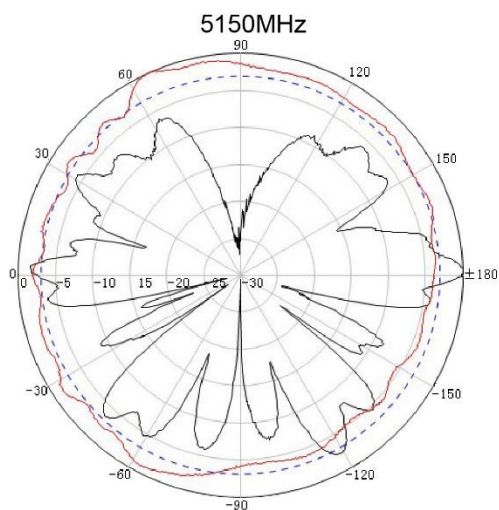
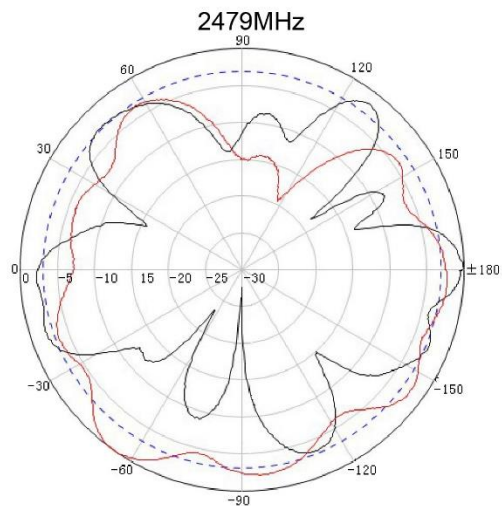
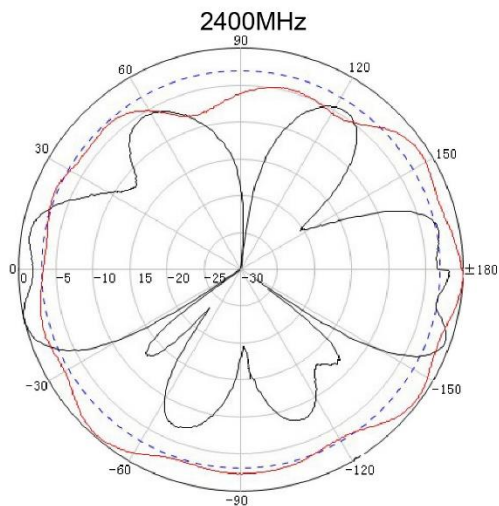

© 2017 ALFA Network Inc. All Rights Reserved *Specifications may change at any time without prior notice

➤ 2D Diagram

