

Order product
from Getic

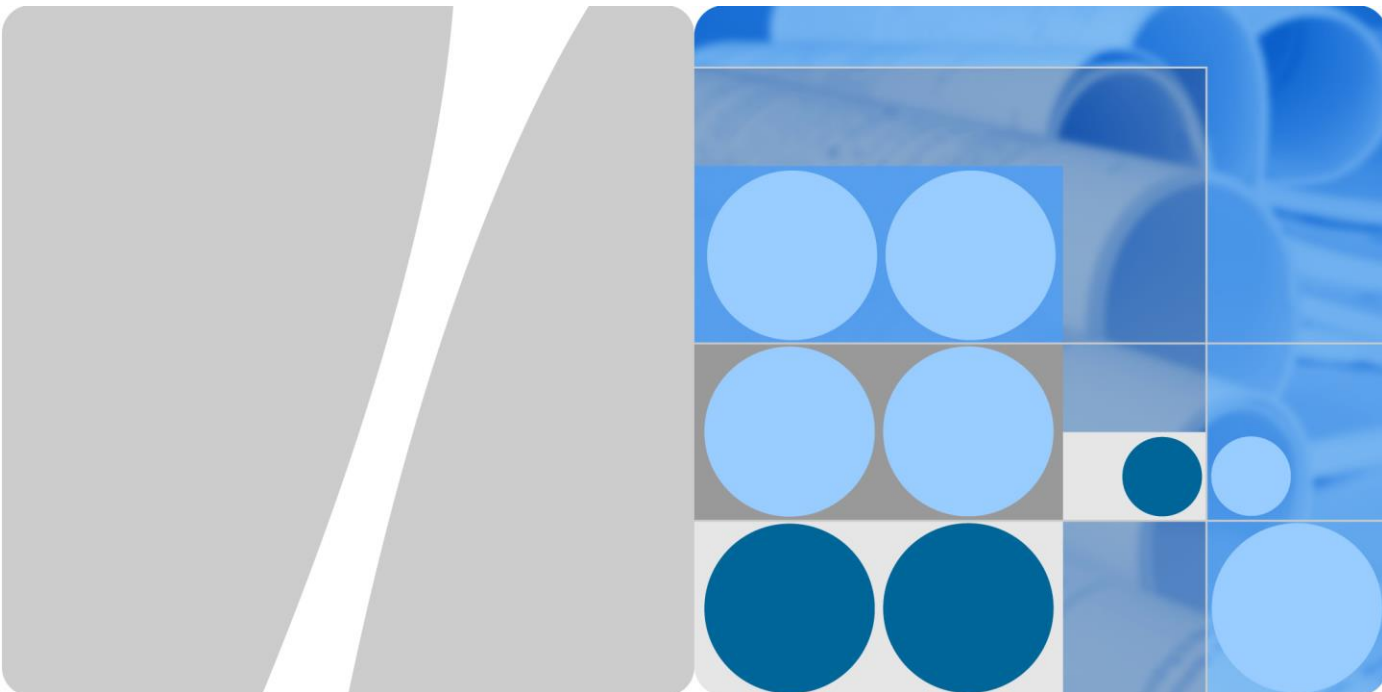

**HUAWEI B535-333 LTE CPE
V100R001**

Product Description

Issue 02

Date 2020-12-23



Copyright © Huawei 2020. All rights reserved.

No part of this document may be reproduced or transmitted in any form or by any means without prior written consent of Huawei Technologies Co., Ltd.

Trademarks and Permissions

All other trademarks and trade names mentioned in this document are the property of their respective holders.

Notice

The purchased products, services and features are stipulated by the contract made between Huawei and the customer. All or part of the products, services and features described in this document may not be within the purchase scope or the usage scope. Unless otherwise specified in the contract, all statements, information, and recommendations in this document are provided "AS IS" without warranties, guarantees or representations of any kind, either express or implied.

The information in this document is subject to change without notice. Every effort has been made in the preparation of this document to ensure accuracy of the contents, but all statements, information, and recommendations in this document do not constitute a warranty of any kind, express or implied.

Huawei Device Co., Ltd.

Address: No.2 of Xincheng Road
Songshan Lake Zone
Dongguan, Guangdong 523808
People's Republic of China

Website: <http://consumer.huawei.com/en/>

Email: mobile@huawei.com

About This Document

Summary

This document provides information regarding the features, main functions and services, technical specifications, and technical references of the product.

This document includes:

Chapter	Details
1 Product Overview	Provides an overview of the product.
2 Technical Specifications	Describes the specifications of the product hardware, software, and user interface.
3 Services and Applications	Describes the main functions and applications of the product.
4 System Structure and Scenario Constraints	Describes the product system structure.
5 Technical References	Describes the standards and communication protocols of the product.
6 Packing List	Describes the devices and accessories that comprise the product package



NOTE

The document is an invitation to offer but not an offer. It is intended to describe the general features and functions of a product. The features and functions of certain products may vary with the requirements of customers.

History

Issue	Date	Details
01	2020-12-14	Initial official release.
02	2020-12-23	Modified weight: < 330g (excluding the power adapter)

Acronyms and Abbreviations

Acronym or Abbreviation	Full Spelling
3GPP	3rd Generation Partnership Project
ACS	Auto Configuration Server
AES	Advanced Encryption Standard
ALG	Application Layer Gateway
AMR-NB	Adaptive Multi-Rate compression - Narrowband
AMR-WB	Adaptive Multi-Rate compression - Wideband
AP	Access Point
APN	Access Point Name
ARP	Address Resolution Protocol
CLAT	Customer-side Translator
CPE	Customer Premises Equipment
CS	Circuit Switched
CSFB	Circuit Switched Fallback
DBDC	Dual Band Dual Concurrent
DC-HSPA+	Dual-Carrier - High Speed Packet Access Evolution
DHCP	Dynamic Host Configuration Protocol
DL	Downlink
DMZ	Demilitarized Zone
DNS	Domain Name Server
DTMF	Dual-Tone Multi-Frequency
E-UTRA	Evolved Universal Terrestrial Radio Access Network
FDD	Frequency Division Duplex
HOTA	Huawei Firmware Over the Air
HSPA	High Speed Packet Access
HSPA+	High Speed Packet Access Evolution
GPRS	General Packet Radio Service
IEEE	Institute of Electrical and Electronics Engineers
IP	Internet Protocol
IPSec	Internet Protocol Security

Acronym or Abbreviation	Full Spelling
IPv4	Internet Protocol version 4
IPv6	Internet Protocol version 6
ICMP	Internet Control Message Protocol
L2TP	Layer Two Tunneling Protocol
LAN	Local Area Network
LED	Light Emitting Diode
LTE	Long Term Evolution
MAC	Media Access Control
MDI	Medium Dependent Interface
MDIX	Medium Dependent Interface Crossover
MIMO	Multi-input Multi-output
MME	Mobility Management Entity
NAT	Network Address Translation
NAPT	Network Address and Port Translation
PC	Personal Computer
PCC	Primary Component Carrier
PGW	PDN Gateway
PIN	Personal Identification Number
PLAT	Provider-side Translator
PPTP	Point-to-Point Tunneling Protocol
QAM	Quadrature Amplitude Modulation
QR	Quick Response
RFC	Request For Comments
RTCP	Real-time Transport Control Protocol
RTP	Real-time Transport Protocol
SAMBA	System for Advanced Mobile Broadband Applications
SCC	Secondary Component Carrier
SCP	Service Control Point
SDRAM	Synchronous Dynamic Random Access Memory
SDP	Session Description Protocol
SGW	Serving Gateway

Acronym or Abbreviation	Full Spelling
SIP	Session Initiation Protocol
SMA	SubMiniature version A
SMS	Short Message
SOHO	Small Office Home Office
SSID	Service Set Identifier
TDD	Time Division Duplex
TD-SCDMA	Time Division-Synchronous Code Division Multiple Access
TKIP	Temporal Key Integrity Protocol
UE	User Equipment
UL	Uplink
UMTS	Universal Mobile Telecommunications System
UPnP	Universal Plug and Play
USB	Universal Serial Bus
USIM	UMTS Subscriber Identity Module
VPN	Virtual Private Network
WAN	Wide Area Network
WEP	Wireless Encryption Protocol
Wi-Fi	Wireless Fidelity
WMM	Wi-Fi Multimedia
WPA/WPA2-PSK	Wi-Fi Protected Access/Wi-Fi Protected Access II - Pre-Shared Key
WPA2-PSK	Wi-Fi Protected Access II - Pre-Shared Key
WPS	Wi-Fi Protected Setup

Contents

About This Document	ii
1 Product Overview	1
2 Technical Specifications	2
2.1 Hardware Specifications	2
2.2 Antenna Specifications	6
2.2.1 Build-in LTE Antenna.....	6
2.2.2 Build-in Wi-Fi Antenna	8
2.3 Software Specifications	8
3 Services and Applications	13
3.1 Data Services	13
3.1.1 Accessing the Internet through a Mobile Network	13
3.1.2 Accessing the Internet through an Ethernet Network	14
3.2 Voice Services.....	14
3.3 SMS	14
3.4 Security Service	14
3.4.1 Firewall Service	15
3.4.2 MAC Filtering	15
3.4.3 Wi-Fi Authentication	15
3.5 VPN Function	15
3.5.1 VPN Client.....	15
3.5.2 VPN Pass-Through	15
3.6 IP Pass-Through.....	16
3.7 IPv6 Only and IPv4v6 Dual Stack.....	16
3.7.1 IPv4v6 Dual Stack	16
3.7.2 IPv6 Only (CLAT)	16
3.8 Multi-APN	17
3.9 5GHz Preferred.....	17
3.10 HiLink.....	18
3.11 Customer management.....	18
3.11.1 WebUI.....	18
3.11.2 HUAWEI AI Life APP.....	18
3.12 Operator maintenance	18

3.13 HOTA	18
4 System Structure and Scenario Constraints.....	19
4.1 System Architecture.....	19
4.2 Scenario Constraints	20
5 Technical References.....	21
5.1 Standards and Communication Protocols	21
5.1.1 Standards and Communication Protocols of the Product.....	21
5.1.2 Standards and Communication Protocols of the Wireless Uu Interface.....	21
6 Packing List.....	22

1 Product Overview

The HUAWEI LTE CPE B535-333 is a Long Term Evolution (LTE) wireless gateway for multiple users in household or small office environments. It enables users to access the Internet.

The B535-333 supports 3GPP Release 11 with LTE CAT 13. The supported service functions are as follows:

- Data service up to DL 400 Mbps(256QAM) and UL 150 Mbps(64QAM)
- Working band: LTE: B1/B3/B7/B8/B20/B28/B32/B38, UMTS: B1/B8
- Voice service: CS/VoIP (Optional) / VoLTE (Optional)
- Wi-Fi: 802.11 b/g/n/a/ac. 2.4GHz Wi-Fi 2x2 MIMO up to 300Mbps, 5GHz Wi-Fi 2x2 MIMO up to 867Mbps. Maximum Users: 64
- 1 GE port for LAN/WAN, 3 GE ports for LAN
- Multi APN function (Optional) for Data, Voice (VoIP), TR-069 services
- Routing mode: NAT enable (Default) / IP pass-through (Optional)
- VPN client service (L2TP, PPTP)
- Customer management via WebUI or HUAWEI AI Life APP (Android)
- Operator maintenance via TR-069 (Optional) and TR-143 (Optional)
- Huawei Firmware Over the Air (HOTA)

2 Technical Specifications

2.1 Hardware Specifications

Table 2-1 Technical specifications of the B535-333 main unit

Item	Description	
Technical standard	WAN	3GPP Release 11
	LAN	IEEE 802.3/802.3u
	Wi-Fi	IEEE 802.11a/b/g/n/ac
Working band/frequency	LTE	B1/B3/B7/B8/B20/B28/B32/B38
	UMTS	B1/B8
	Wi-Fi	2.4 GHz: 2.4 GHz-2.4835 GHz, 5.0 GHz: 5.17 GHz-5.33 GHz & 5.49 GHz-5.71 GHz & 5.735 GHz -5.835 GHz
External port	<ul style="list-style-type: none"> • One power adapter port • One LAN/WAN port (RJ45), three LAN ports (RJ45) • One phone port (RJ11) • Two external LTE antenna ports (SMA) • One SIM card slot (nano-SIM) 	
Antennas	<ul style="list-style-type: none"> • Built-in LTE/UMTS primary antenna • Built-in LTE/UMTS secondary antenna • Built-in Wi-Fi 2.4 GHz and 5.0 GHz antenna 	

Item	Description			
LED Indicators	<ul style="list-style-type: none"> • One Internet status indicator White: Connected to the Internet. Red: No SIM card is inserted or detected, or the SIM card has insufficient balance. • One Wi-Fi indicator On: Wi-Fi is enabled. Flash slowly: A pairable HiLink device is detected. Flash quickly: HiLink pairing is in progress/WPS connection is in progress. Off: Wi-Fi is disabled. <p> NOTE</p> <ul style="list-style-type: none"> • The indicator starts to flash slowly only when B535-333 detects a new HiLink device. • HiLink devices include Honor routers, Honor set-up boxes, Honor handsets (EMUI 5.0 and later), and more. • One group of signal strength indicators Signal reception available (more indicators mean better reception). 			
Buttons	<ul style="list-style-type: none"> • One Power ON/OFF switch • One H button <ul style="list-style-type: none"> • The Wi-Fi indicator flashes slowly when the router detects a HiLink device. Press the H button to connect the HiLink device to the router's Wi-Fi. • When the Wi-Fi indicator is steady on, press the H button to enable WPS. • One Reset button 			
Maximum transmit power	LTE	<ul style="list-style-type: none"> • B1/B3/B38: 22.5 dBm ±1.2 dB • B7: 22 dBm ±1.2 dB • B8/28: 23 dBm ±1.2 dB • B20: 23.5 dBm ±1.2 dB 		
	UMTS	<ul style="list-style-type: none"> • B1: 23 dBm ±1.2 dB • B8: 23.5 dBm ±1.2 dB 		
	Wi-Fi	2.4G	802.11b	SISO Ant0/Ant1 13.5/14 dBm(±2dB)
			802.11g	SISO Ant0/Ant1 15.5/16 dBm(±2dB) MIMO 14.5 dBm(±2dB)
802.11n-20M			SISO Ant0/Ant1 15.5/16 dBm(±2dB) MIMO 14.5 dBm(±1.5dB)	
802.11n-40M			SISO Ant0/Ant1 15.5/16 dBm(±2dB) MIMO 14.5 dBm(±1.5dB)	

Item	Description							
	5G	5G LF (±2 dB) *Some edge band power is reduced		5G MF (±2 dB) *Some edge band power is reduced		5G HF (±2 dB) *Some edge band power is reduced		
		Ant0	Ant1	Ant0	Ant1	Ant0	Ant1	
	11a 6M	16	16	16.5	16.5	23	23	
	11a 54M	16	16	16.5	16.5	20	20	
	11n 20M MCS0	16	16	16.5	16.5	23	23	
	11n 20M MCS7	16	16	16.5	16.5	20	20	
	11n 40M MCS0	18	18	18.5	18.5	23	23	
	11n 40M MCS7	18	18	18.5	18.5	20	20	
	11ac 20M MCS0	16	16	16.5	16.5	23	23	
	11ac 20M MCS8	16	16	16.5	16.5	18	18	
	11ac 40M MCS0	18	18	18	18	23	23	
	11ac 40M MCS9	18	18	18	18	18	18	
	11ac 80M MCS0	18	18	18	18	23	23	
	11ac 80M MCS9	18	18	18	18	18	18	
Receiving sensitivity	LTE	Band	1.4MHz (dBm)	3MHz (dBm)	5MHz (dBm)	10MHz (dBm)	15MHz (dBm)	20MHz (dBm)
		B1	/	/	-100.3	-97.3	-95.5	-94.3
		B3	-102	-99	-97.3	-94.3	-92.5	-91.3
		B7	/	/	-98.3	-95.3	-93.5	-92.3

Item	Description							
		B8	-102.5	-99.5	-97.3	-94.3	/	/
		B20	/	/	-97.3	-94.3	-91.5	-90.3
		B28	/	-100.5	-98.8	-95.8	-94	-91.3
		B32	/	/	-100.8	-99.8	-96.8	-95.8
		B38	/	/	-100.3	-97.3	-95.5	-94.3
	UMTS	<ul style="list-style-type: none"> • B1: -107.7 dBm • B8: -104.7 dBm 						
	Wi-Fi	<ul style="list-style-type: none"> • 2.4G 802.11b: -87 dBm • 2.4G 802.11g: -74 dBm • 2.4G 802.11n 20M: -72 dBm • 2.4G 802.11n 40M: -70 dBm • 5G 802.11a: -74 dBm • 5G 802.11n 20M: -73 dBm • 5G 802.11n 40M: -69 dBm • 5G 802.11ac 20M: -67 dBm • 5G 802.11ac 40M: -65 dBm 5G 802.11ac 80M: -60 dBm 						
Power consumption	< 12 W							
AC/DC power supply	<ul style="list-style-type: none"> • AC (input): 100V-240V 50Hz/60Hz • DC (output): 12V/1A 							
Dimensions (Maximum)	219 mm (Width) x 138 mm (High) x 25.6 mm (Deep)(not included the socket) 219 mm (Width) x 138 mm (High) x 60.66 mm (Deep)(included the socket)							
Weight	< 330g (excluding the power adapter)							
Temperature	<ul style="list-style-type: none"> • Working temperature: 0°C to 40°C • Storage temperature: -20°C to +70°C 							
Humidity	5% – 95% (non-condensing)							
Certification/Compliance	CE Wi-Fi ERP GCF WEEE ROHS REACH							

Table 2-2 LTE CA combination

Item	Description		
Band combination	LTE	DL	MIMO
		CA_1C	2+2
		CA_3C	2+2
		CA_7C	2+2
		CA_38C	2+2
		CA_3A-3A	2+2
		CA_1A-3A	2+2
		CA_1A-7A	2+2
		CA_1A-8A	2+2
		CA_1A-20A	2+2
		CA_1A-28A	2+2
		CA_3A-7A	2+2
		CA_3A-8A(B8 only SCC)	2+2
		CA_3A-20A	2+2
		CA_3A-28A	2+2
		CA_7A-8A(B8 only SCC)	2+2
		CA_7A-20A	2+2
		CA_7A-28A	2+2
		CA_20A-32A(B32 only SCC)	2+2
		CA_20A-38A	2+2
		UL	MIMO
		CA_1C	/
		CA_3C	/
CA_7C	/		
CA_38C	/		

2.2 Antenna Specifications

2.2.1 Build-in LTE Antenna

Table 2-3 LTE antenna specifications

Item	Description
Frequency	<p>FDD LTE</p> <ul style="list-style-type: none"> • B1: UL 1920-1980 MHz DL 2110-2170 MHz • B3: UL 1710-1785 MHz DL 1805-1880 MHz • B7: UL 2500-2570 MHz DL 2620-2690 MHz • B8: UL 880-915 MHz DL 925-960 MHz • B20: UL 832-862 MHz DL 791-821 MHz • B28: UL 703-748 MHz DL 758-803 MHz • B32: NA DL 1452-1496 MHz <p>TDD LTE</p> <ul style="list-style-type: none"> • B38: UL 2570-2620 MHz DL 2570-2620 MHz

Item	Description
	UMTS <ul style="list-style-type: none"> • B1: UL 1920-1980 MHz DL 2110-2170 MHz • B8: UL 880-915 MHz DL 925-960 MHz
Input impedance	50 Ω
Standing wave ratio	< 3
Main antenna efficiency	LTE <ul style="list-style-type: none"> • B1: -1.5 dB • B3: -1.4 dB • B7: -1.7 dB • B8: -2.6 dB • B20: -2.1 dB • B28: -2.5 dB • B32: -2.6 dB • B38: -1.8 dB UMTS <ul style="list-style-type: none"> • B1: -1.5 dB • B8: -2.6 dB
Diversity antenna efficiency	LTE <ul style="list-style-type: none"> • B1: -2.3 dB • B3: -2.2 dB • B7: -2.5 dB • B8: -3.1 dB • B20: -2.7 dB • B28: -3.2 dB • B32: -3.3 dB • B38: -2.3 dB UMTS <ul style="list-style-type: none"> • B1: -2.3 dB • B8: -3.1 dB
Main antenna gain	LTE <ul style="list-style-type: none"> • B1/B3/B7/B8/B20/B28/B32/B38: 1~2 dBi UMTS <ul style="list-style-type: none"> • B1: 2 dBi • B8: 0.8 dBi
Diversity antenna gain	LTE B1/B3/B7/B8/B20/B28/B32/B38: 1~2 dBi
TX/RX	1T2R
Polarization	Linear polarization

2.2.2 Build-in Wi-Fi Antenna

Table 2-4 Wi-Fi 2.4 GHz antenna specifications

Item	Description
Frequency	2.4 GHz-2.4835 GHz
Input impedance	50 Ω
Standing wave ratio	< 2
Efficiency	-3 dB
Gain	≤ 2.55 dBi
Polarization	Linear polarization

Table 2-5 Wi-Fi 5.0 GHz antenna specifications

Item	Description
Frequency	5.17 GHz-5.33 GHz & 5.49 GHz-5.71 GHz & 5.735 GHz -5.835 GHz
Input impedance	50 Ω
Standing wave ratio	< 2
Efficiency	-3 dB
Gain	≤ 2.9 dBi
Polarization	Linear polarization

2.3 Software Specifications

Table 2-6 Software specifications

Item	Description	
LTE features	DL 2x2 MIMO	
	DL 256 QAM, UL 64 QAM	
Mobile network	APN management APN auto adapter	
Gateway	Router	<ul style="list-style-type: none"> Supports the default route: 192.168.8.1. Supports manual configuration of LAN IP addresses. Supports Address Resolution Protocol (ARP).

Item	Description	
	DHCP server	<ul style="list-style-type: none"> • The DHCP server can be enabled or disabled. • The address pool of the DHCP server can be configured. • The lease can be configured. • Supports the DHCP server and DNS relay.
	NAT	<ul style="list-style-type: none"> • Supports NAT and NAPT (compliant with RFC2663, RFC3022, and RFC3027). • Supports cone NAT. • Supports Symmetric NAT.
	ARP	
	ICMP	
	IPv4v6 dual stack IPv6 only (Optional , CLAT for LAN side IPv4 device access Internet) IPv4 only (Optional)  NOTE When the CLAT function is enabled, the IPv4 device Internet access service cannot reach the maximum throughput. Under IPv6 only, NAT-base service (such as port forwarding and port triggering) is not available.	
	VPN pass-through	
VPN client	<ul style="list-style-type: none"> • Support L2TP VPN client • Support PPTP VPN client 	
SMS	<ul style="list-style-type: none"> • Writing/sending/receiving • Writing/sending/receiving extra-long messages 	
Data service	LTE : DL 400 Mbps, UL 150 Mbps DC-HSPA+: DL 42 Mbps, UL 5.76 Mbps HSPA+: DL 21 Mbps (64QAM), UL 5.76 Mbps HSPA: DL 14.4 Mbps, UL 5.76 Mbps WCDMA PS: DL 384 Kbps, UL 384 Kbps	
	Wi-Fi 802.11b/g/n/a/ac	
	Supports multi APNs (Optional, one for data, one for voice, and one for TR-069).	
Voice	VoIP (Optional)	Supports G.711a/G.711u/G.726 (-24/-32)/G.722/G.729 codec. Supports SIP (RFC3261). Supports SDP (RFC2327). Supports RTP/RTCP (RFC1889/RFC1890/RFC3550).

Item	Description	
		<p>Supports in-band/SIP info/RFC2833 DTMF.</p> <p>Supports the following phone features:</p> <ul style="list-style-type: none"> • Caller ID generation • Call waiting • Call forwarding (unconditional, busy, and no answer forwarding) • Call hold • Three-way conference
	CS	<p>Supports CS voice communication over UMTS networks.</p> <p>Supports circuit switched fallback (CSFB).</p> <p>Supports the following phone features:</p> <ul style="list-style-type: none"> • Caller ID generation • Call waiting • Call forwarding (unconditional, busy, and no answer forwarding) • Call hold • Three-way conference • Originating Identification Presentation/Restriction • Outgoing Communication Barring
	VoLTE (Optional)	<ul style="list-style-type: none"> • Supports AMR-NB codec • Supports AMR-WB codec <p>Supports SRVCC to UMTS</p> <p>Supports in-band/out-band (RFC2833) DTMF</p> <p>Supports the following phone features:</p> <ul style="list-style-type: none"> • Caller ID generation • Call waiting • Call forwarding (unconditional, busy, and no answer forwarding) • Call hold • Three-way conference • Originating Identification Presentation/Restriction • Outgoing Communication Barring

Item	Description	
Firewall setup	<ul style="list-style-type: none"> • Firewall enable/disable • URL filtering • LAN IP filtering • Port forwarding (Virtual server) • Port triggering (Special Application) • DMZ service • UPnP service • ALG settings 	
LAN	<ul style="list-style-type: none"> • 10/100/1000 Mbps auto-negotiation • MDI/MDIX auto-sensing • IEEE 802.3/802.3u-compatible 	
Wi-Fi	Broadcasts and hides service set identifiers (SSIDs)	
	Complies with IEEE 802.11b/g/n/a/ac	
	WPS	
	WMM	
	Encryption	WEP, AES, and TKIP + AES
	Security mode	<ul style="list-style-type: none"> • Open • WPA2-PSK • WPA/WPA2-PSK • WEP • WPA3-SAE • WPA2-PSK/WPA3-SAE
	MAC address authentication	<ul style="list-style-type: none"> • Supports the MAC address authentication whitelist. • Supports the MAC address authentication blacklist. • Supports a maximum of 32 MAC address entries.
STA	<ul style="list-style-type: none"> • Supports inquiry of STA status. • Supports a maximum of 64 connected stations. 	
Operator maintenance (Optional)	<ul style="list-style-type: none"> • Supports TR-069 Amendment III • Supports TR-098 Amendment II • Supports TR-143 Amendment I • Supports TR-104 Amendment I (if VoIP is available) 	
USIM	PIN management and USIM card authentication	
NTP	Supports daylight saving time (DST) (Optional).	
Maintenance	Supports viewing the current diagnosis results and operation logs.	

Item	Description	
HUAWEI AI Life APP	<ul style="list-style-type: none"> • View data traffic usage and SMS. • Manage connected devices. • Change CPE's SSID and password. 	
System requirements	Operating system	Windows 8, Windows 8.1, Windows 10 (Not support Windows RT), MAC OS X 10.12, 10.13, 10.14 and 10.15.
	Web browser	<ul style="list-style-type: none"> • Microsoft Internet Explorer 9.0 and Microsoft Edge 14.0 with latest updates. • Firefox 60.0 with latest updates. • Chrome 60.0 with latest updates. • Safari 10.0 with latest updates. • Opera 51.2 with latest upgrades.
	Your computer's hardware system should meet or exceed the recommended system requirements for the installed OS version.	

3 Services and Applications

3.1 Data Services

The B535-333 can access the Internet through mobile networks and Ethernet networks. By connecting to the B535-333 using Wi-Fi or a network cable, users can obtain access to high-speed Internet services and establish a local area network (LAN).

3.1.1 Accessing the Internet through a Mobile Network

The B535-333 can access the Internet through mobile networks.

Figure 3-1 Accessing the Internet through a mobile network

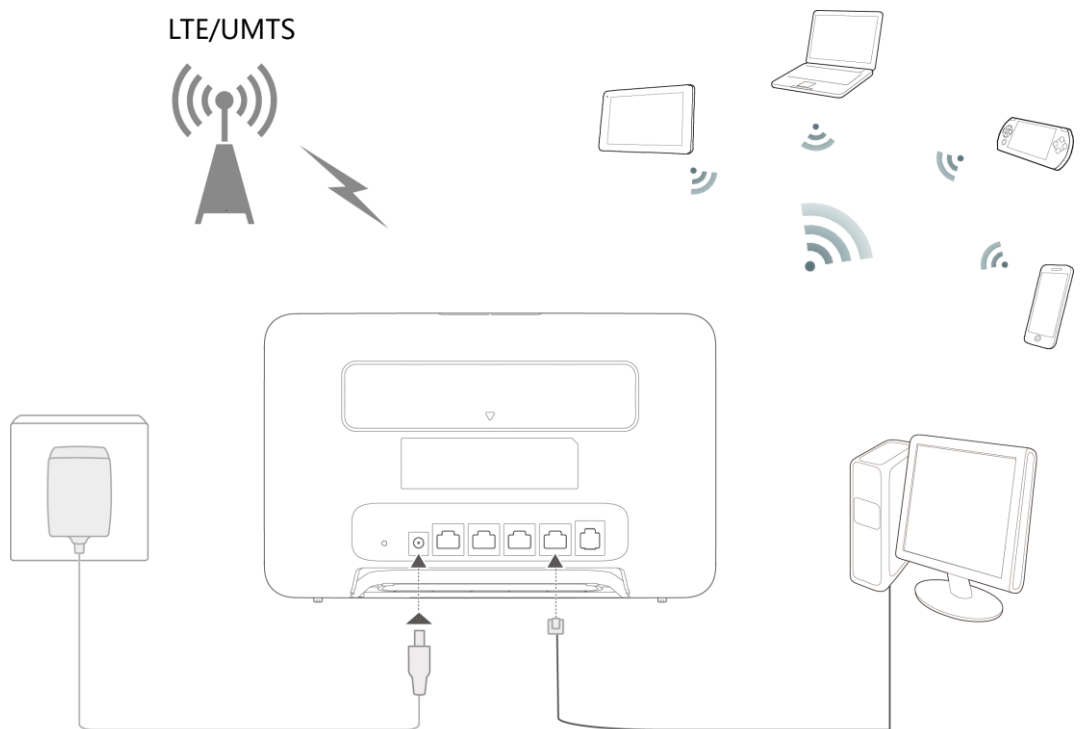

3.1.2 Accessing the Internet through an Ethernet Network

The B535-333's LAN/WAN port can be connected to a wall-mounted Ethernet port using a network cable.

Figure 3-2 Accessing the Internet through an Ethernet network

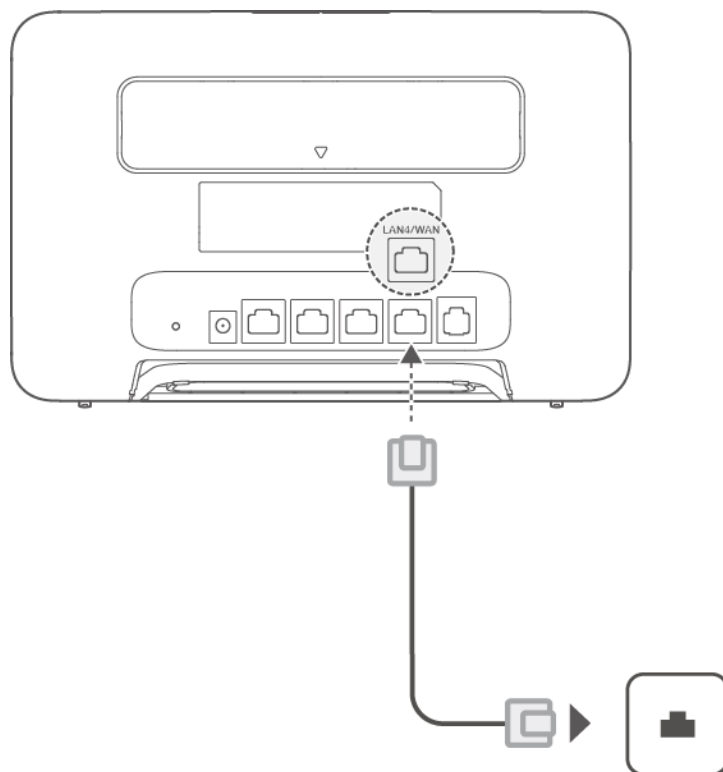

3.2 Voice Services

The B535-333 provides one telephone port that can be connected to telephones for calling.

3.3 SMS

The B535-333 supports message writing/sending/receiving and group sending (up to 50 -contacts at a time).

3.4 Security Service

The B535-333 supports comprehensive and robust security services. It provides a firewall function and PIN protection mechanisms. These features allow users to connect their computers to the Internet and simultaneously protect their computers against security threats from the Internet.

3.4.1 Firewall Service

The B535-333 supports the enabling or disabling of a firewall on the network connection, which protects the device and network from attacks by hackers on the Internet and controls access to the Internet.

3.4.2 MAC Filtering

The B535-333 supports configuration of the Media Access Control (MAC) address to restrict network access.

3.4.3 Wi-Fi Authentication

The gateway supports the following user authentication protocols for Wi-Fi:

- No encryption.
- WEP, WPA2-PSK (AES), WPA/WPA2-PSK (TKIP/AES), WPA3-SAE, WPA2-PSK/WPA3-SAE.

3.5 VPN Function

3.5.1 VPN Client

VPN tunneling involves establishing and maintaining a logical network connection (that may contain intermediate hops). On this connection, packets constructed in a specific VPN protocol format are first encapsulated within some other base or carrier protocol, then transmitted between the VPN client and server, and finally decapsulated on the receiving side.

The B535-333 supports L2TP and PPTP tunneling protocols.

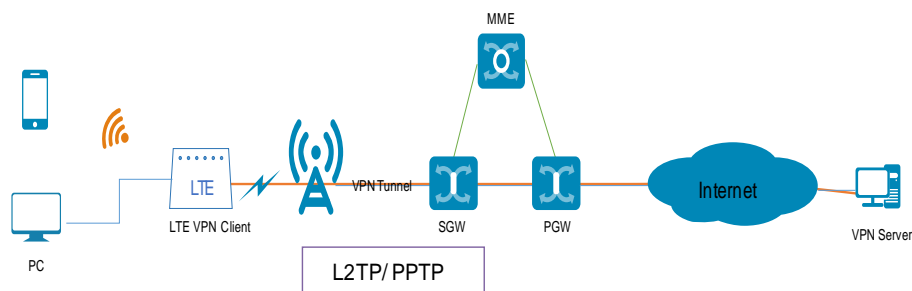

3.5.2 VPN Pass-Through

The B535-333 supports L2TP/PPTP/IPsec VPN pass-through for the LAN side device. The LAN side device can create a VPN tunnel to the VPN server.

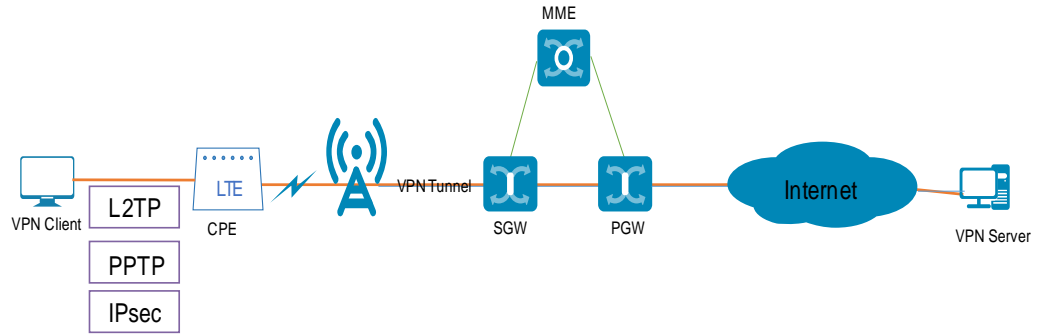

3.6 IP Pass-Through

The LTE CPE obtains the WAN IP address and passes it through to the PC (Case 1) or Router (Case 2), and then the PC (Case 1) or Router (Case 2) can directly use the WAN IP address.

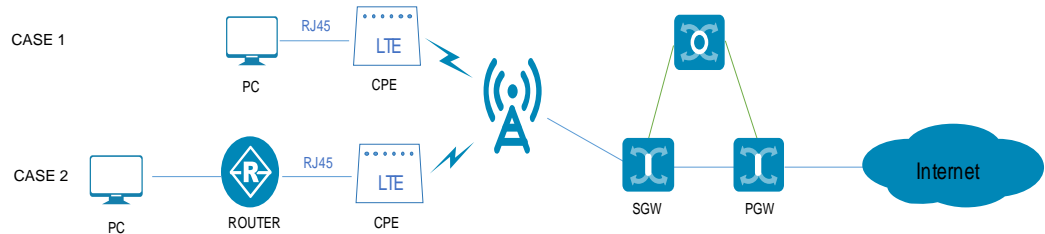

3.7 IPv6 Only and IPv4v6 Dual Stack

3.7.1 IPv4v6 Dual Stack

CPE provides dual stack function.

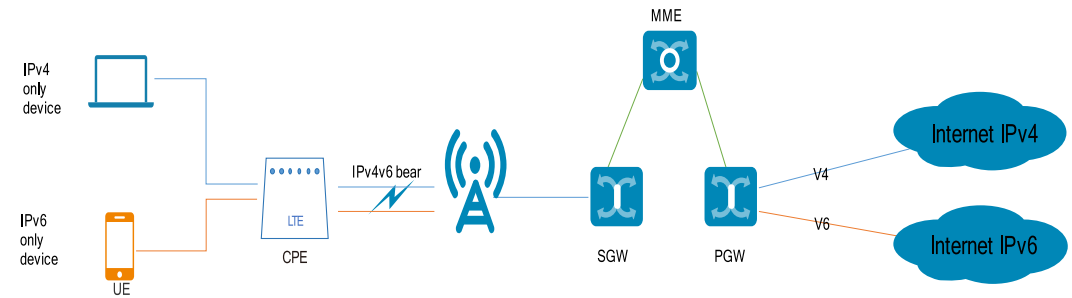

3.7.2 IPv6 Only (CLAT)

The LTE CPE supports IPv6 only with the transition solution CLAT for IPv4 device.

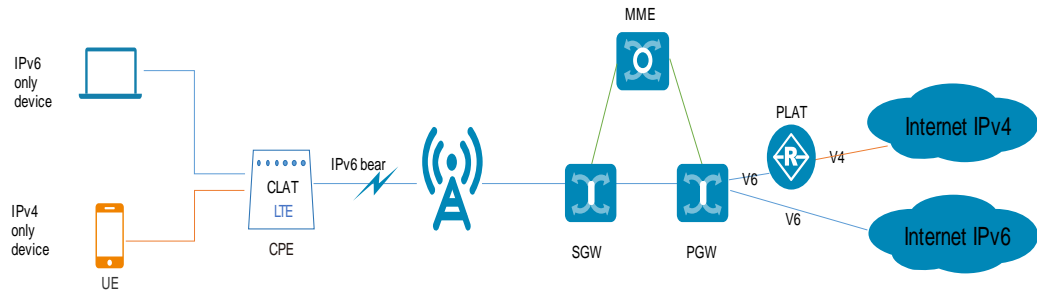

NOTE

When the IPv6 only (CLAT) function is enabled, NAT-based functions (like DMZ/Port Forwarding/Port tigger) cannot be used.

When an IPv4 device accesses the Internet, the performance is degraded because packets need to be packetized and unpacked. However, IPv6 devices are not affected.

3.8 Multi-APN

The B535-333 supports the establishment and maintenance of three APNs. These three APN connections isolate data, voice, and remote management services on an operator's network.

The B535-333 supports an independent APN for CPE internal/VoIP/TR-069.

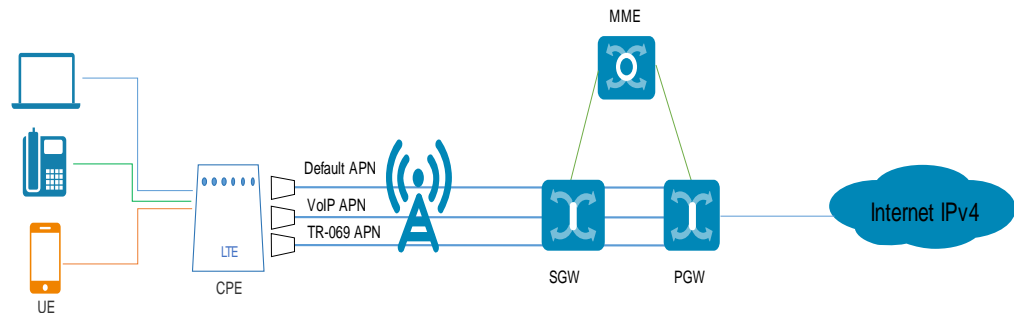

3.9 5GHz Preferred

Priority usage of 5 GHz Wi-Fi band over 2.4 GHz band when signal strength is equal to increase connection speeds.

The product will support two SSIDs when 5 GHz preferred is enabled. The first SSID includes 2.4 GHz Wi-Fi and 5GHz Wi-Fi, which provides 5 GHz preferred capabilities. The second SSID ending with '_5G' is an independent 5 GHz Wi-Fi. Customers can choose according to their needs.

The product also supports two SSIDs when 5 GHz preferred is disabled. The first SSID is only 2.4 GHz Wi-Fi, the second SSID is 5 GHz Wi-Fi ending with '_5G'. Customers can choose according to their needs.

3.10 HiLink

- Supports up to 5 HiLink devices to connect to B535-333 through the H button to create an expanded network.
- Supports quick connection between a HiLink device (such as Honor set-up boxes and Honor handsets running on EMUI 5.0 and later) and B535-333 through the H button.

3.11 Customer management

3.11.1 WebUI

The B535-333 supports local configuration through the Web UI. You can perform device management and network configuration to ensure normal and stable performance.

3.11.2 HUAWEI AI Life APP

Scan the QR code (can be found in the Quick Start Guide, giftbox and Web UI) to download the HUAWEI AI Life APP and configure the router from your phone.

3.12 Operator maintenance

The B535-333 supports Operator maintenance through the TR-069. Operator remote manages the CPE software update/parameters configuration via TR-069.

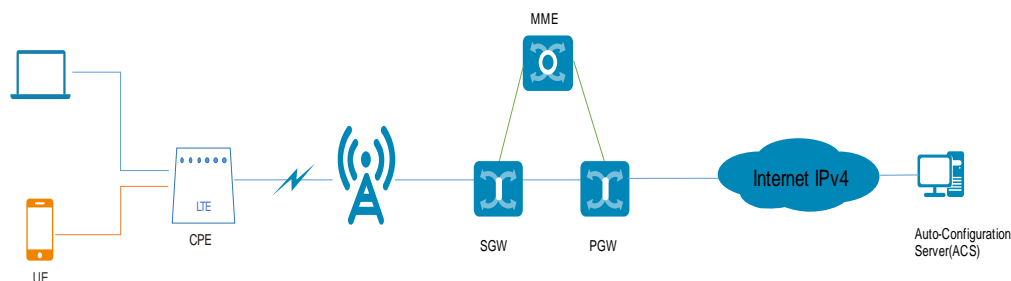

3.13 HOTA

The B535-333 supports the HOTA feature, which allows users to remotely update the device firmware through the HOTA server.

4 System Structure and Scenario Constraints

4.1 System Architecture

Figure 4-1 System structure

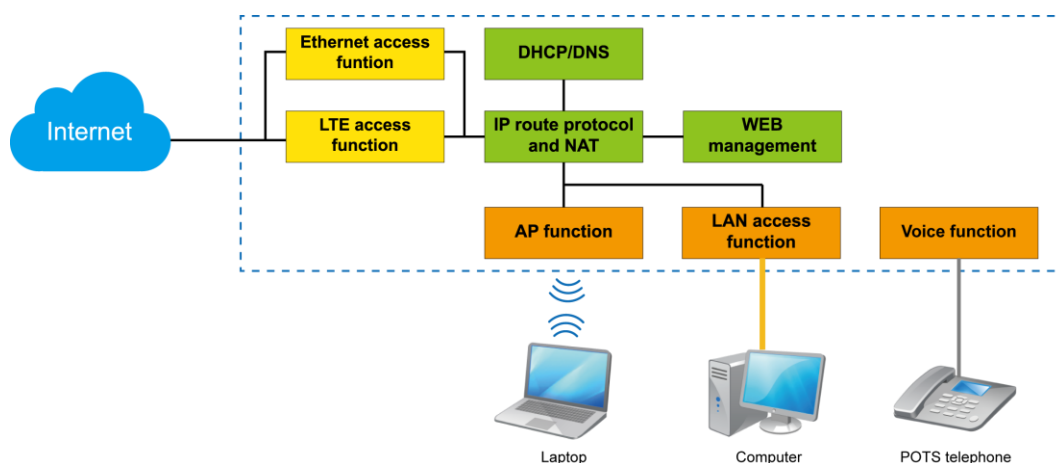

The following describes the modules shown in Figure 4-1.

- LTE access function: The B535-333 adopts the LTE access technology at the WAN side.
- LAN access function: One 10/100/1000 Mbps high-speed Ethernet ports are provided at the LAN side. The B535-333 provides the switching function for local networking and sharing of the broadband network when it is connected to terminal devices.
- AP function: An 802.11b/g/n/a/ac -compliant Wi-Fi AP interface is provided for wireless networking at home. The interface is compliant with the IEEE 802.11b/g/n/a/ac standard and the WEP, WPA/WPA2-PSK, WPA2-PSK, WPA3-SAE, WPA2-PSK/WPA3-SAE security authentication mechanisms.
- DHCP/DNS: The DHCP server dynamically allocates IP addresses to PCs.
- Web-based management: You can configure the B535-333 and modify and view the configuration of the B535-333.
- IP routing protocol and NAT: The B535-333 has high-speed routing capability. With the built-in NAT, the B535-333, together with LTE terminals, can provide flexible broadband access solutions and networking schemes.

- Voice function: The B535-333 supports voice services.

4.2 Scenario Constraints

The B535-333 is a household wireless broadband access product designed for use in scenarios with relatively few network access devices and relatively low network reliability requirements, such as homes or small office and home offices (SOHOs).

The B535-333 is not an enterprise-grade product. It cannot be used by medium- or large-sized enterprises or in scenarios with high network reliability requirements, such as banks, securities agencies, traffic control, and communications device backhaul.

The B535-333 has the following constraints:

- When the IP Pass-Through mode is enabled, the HOTA function cannot be used.
- When the L2TP/PPTP VPN client function is enabled, the throughput performance will slow down.
- A maximum of 64 devices can be connected to the Wi-Fi in theory; the actual number of devices that can be connected and served depends on actual conditions.

5 Technical References

5.1 Standards and Communication Protocols

5.1.1 Standards and Communication Protocols of the Product

Table 5-1 Standards and communication protocols of the product

Item	Description
Physical layer	RFC894
ARP	RFC826
IP	RFC791, RFC1122, RFC1071, RFC1141, RFC1624, RFC792, RFC950, RFC1256
ICMP	RFC792, RFC950, RFC1256
TCP	RFC793
UDP	RFC768
DHCP	RFC1531, RFC1533
NAT	RFC1631, RFC2663, RFC3022, RFC3027

5.1.2 Standards and Communication Protocols of the Wireless Uu Interface

This device supports 3GPP Release 11.

6 Packing List

Table 6-1 Packing list

Description	Quantity	Remarks
Wireless Gateway	1	Standard
Socket	1	Standard
Power supply adapter	1	Standard
Quick Start	1	Standard
Ethernet cable	1	Optional
Phone cable	1	Optional
Warranty card	1	Optional

The HUAWEI B535-333 wireless gateway has an optional external antenna.